

EATON WORKSTATION

1500x1500 / 1800x1800

BEFORE YOU START

- Assembly takes about 10 minutes
- 2 people recommended for assembly
- Assemble on a flat, soft surface (e.g. carpet or rug). If assembling on a hard surface, place some cardboard underneath to avoid scratching the melamine panels.
- When assembling or disassembling panels, only use a hand screwdriver. Cordless screwdrivers with high torque can damage the cam screws.

TOOLS REQUIRED

Phillips #2 Screwdriver

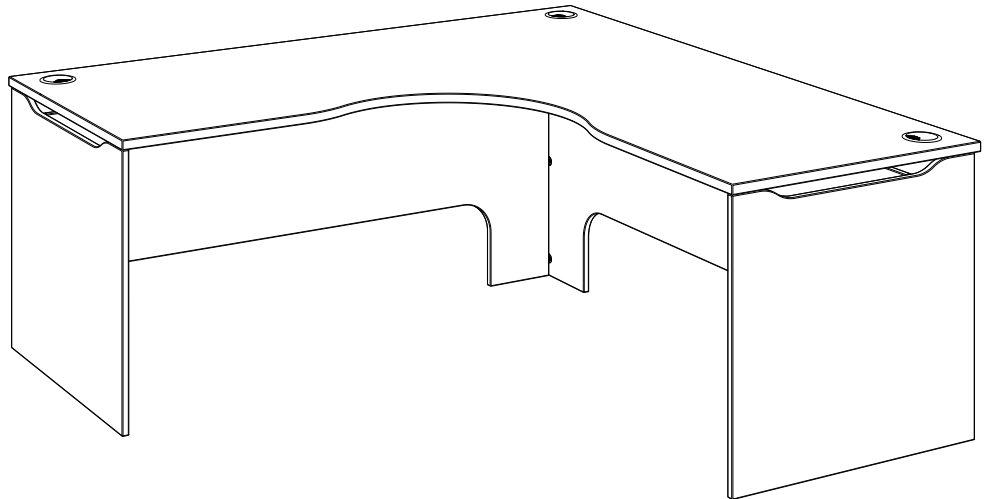
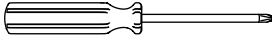

PARTS REFERENCE

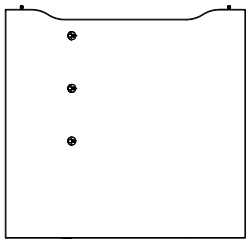

Right Side Panel

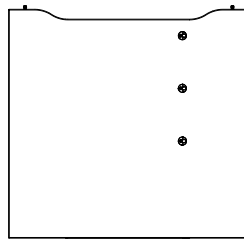

Left Side Panel

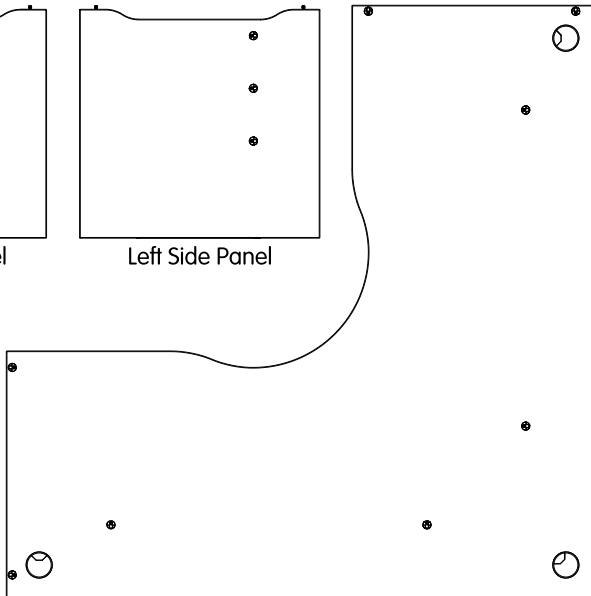

Top Panel

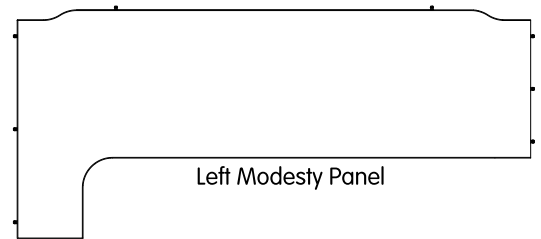

Left Modesty Panel

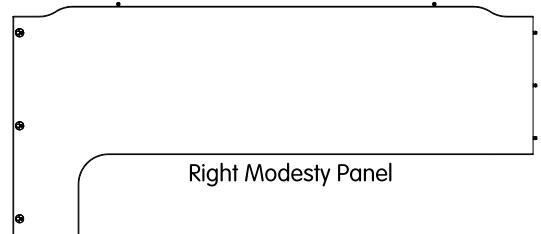

Right Modesty Panel

1

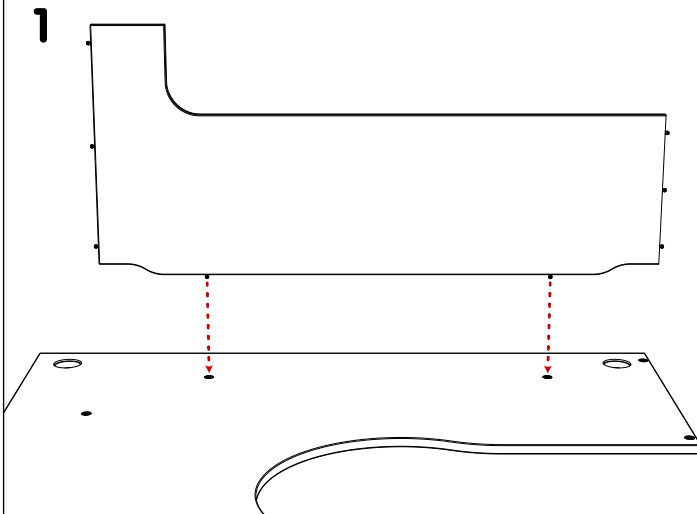

Place the top panel down first and fit the left modesty panel.
Don't lock any cams yet.

2

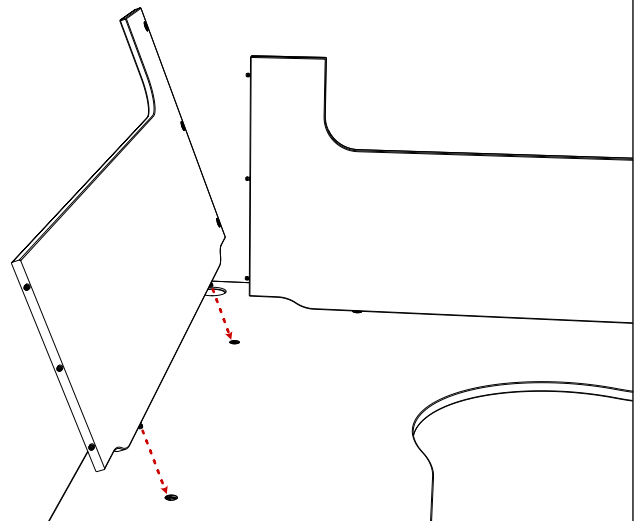

Fit the right modesty panel into the top panel.
Hold it at an angle to avoid hitting the left modesty panel.

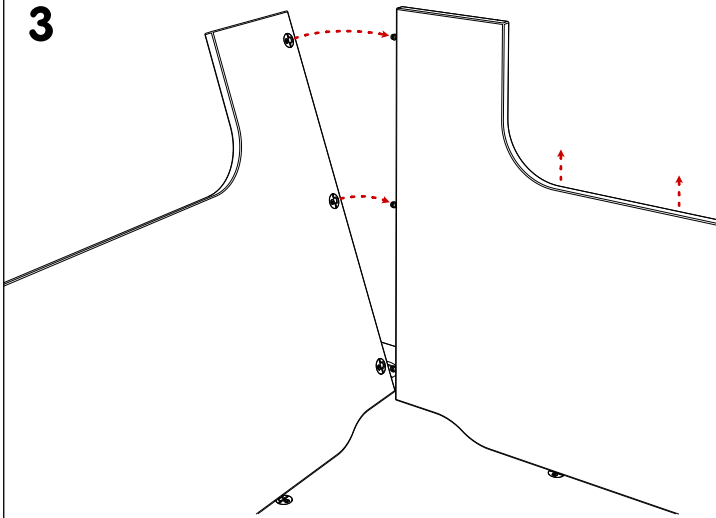
3

Push the right modesty panel upright to fit into the left modesty panel.

You may need to lift the left modesty panel slightly to make sure the pins line up with the cams in the right modesty panel.

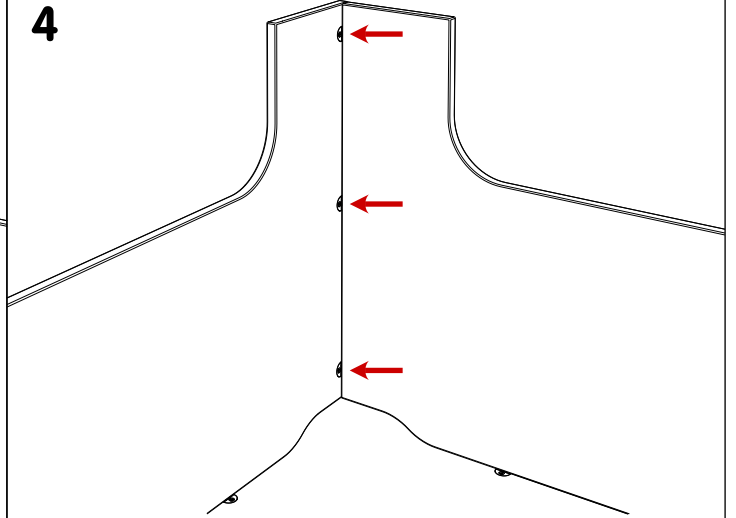
4

Make sure the modesty panels are fitted firmly together with no gaps, then lock the three cams as indicated.

(To lock, turn the cam screw clockwise about 3/4 turn until it stops)

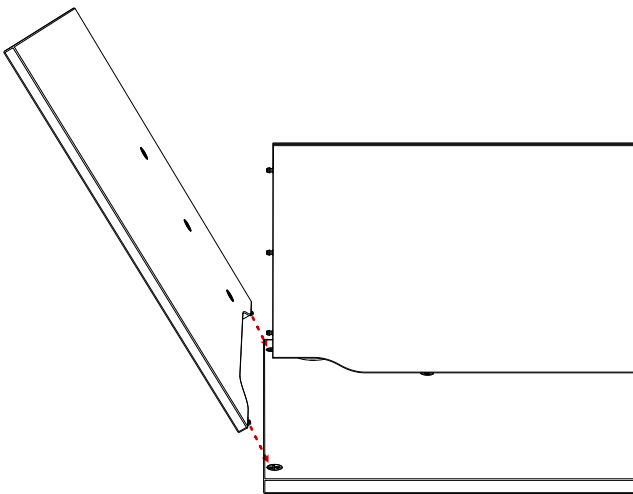
5

Fit the side panel into the top panel.
Hold it at an angle to avoid hitting the modesty panel.

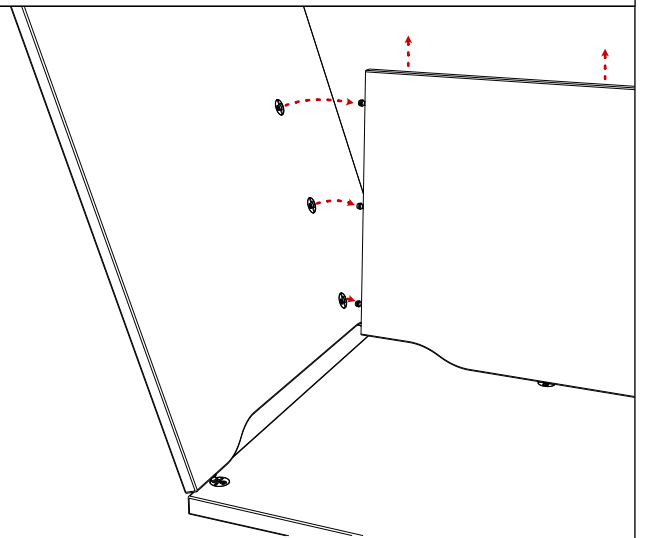
6

Push the side panel upright to fit into the modesty panel.

You may need to lift the modesty panel slightly to make sure the pins line up with the cams in the side panel.

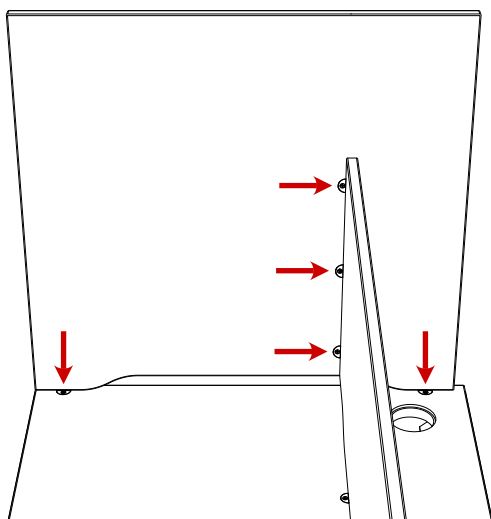
7

Make sure the side panel is fitted firmly into the other panels with no gaps, then lock the five cams as indicated.

Repeat steps 5 to 7 for the other side panel.

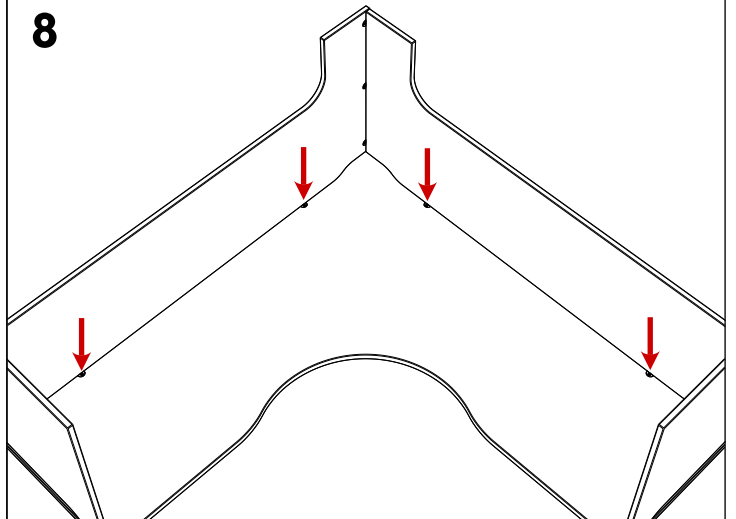
8

Finally, fasten the modesty panels by locking the four cams as indicated.

(For disassembly, simply place the workstation upside-down, unlock all the cams and pull the panels apart)